

**3.5.1 - Revenue generated from consultancy and corporate training during the year  
(INR in lakhs)**



3.5.1 Revenue generated from consultancy and corporate training during the year (INR in lakhs) & 3.5.2 Total amount spent on developing facilities, training teachers and clerical/project staff for undertaking consultancy during the year:

Revenue generated from consultancy during the year

S.NO	Names of the teacher-consultants	Name of the consultancy project	Consulting/Sponsoring agency with contact details	Revenue generated (INR in lakhs)
1	Dr.B.Sreedevi	Health care payment with online sms and payment facility	Vass Software	25000
2	Dr.B.Sreedevi	Website Development	AC DC Bikes	15000
3	Dr.B.SreedeviMr.M.Parthiban	UI design for CRM FARM	Foyer Technology Private Ltd	37500
4	Dr.B.SreedeviMr.M.Parthiban	React JS Validation for CRM FARM	Foyer Technology Private Ltd	37,500
5	Mr.P.Ravavel	Student Innovation Portal	Sairam Incubation	60000
6	Dr.G.Shanmugasundar	Design Of 6 Degrees Of Freedom Articulated Robot For Weld Inspection	CAE Center	10000
7	Dr.M.Mareeswaran	Design of Wind Tunnel	Revo Technologies	500,000
8	Mr.B.karthikevan	Design of Con Mill	Sanjmar Industries (OPC) Private Limited	100,000
9	Dr. MARRESWARAN M.	the Design of Steam Injected Kiln	Sanjmar Industries (OPC) Private Limited	300,000
10	Dr.G.Prakash	Sensor-based espial of potholes and humps on roads with instant notification alert	Thermal Energy Solutions	20,000
11	Mr.R.Dhanasekar	Speed control of DC Motor using Arduino under various load torques	Quality electrical works,chennai-600123.	20,000
12	Mrs.G.Ezhilarasi	Fibre Optic Sensor for Measurement of Surface Properties	Micron Precision Tools	30,000
13	Mr.L. Vijayaraja	Multilevel inverter for Renewable Energy Integration	JSK Lab Instruments	30,000

Revenue generated from corporate training during the year

S.NO	Names of the teacher-consultants/corporate trainers	Title of the corporate training programme	Agency seeking training with contact details	Revenue generated (amount in rupees)	Number of trainees	Month /Year
1	Cappgemini and ICT	Advanced J2EE + Soft skills	CSE/ECE/IT/CCE/AI & DS	180,000	60	Juli 2023
2	Amrita vishwa vidyapeetam	CISCO value added course (CCNA I & II)	CSE/ECE/IT/CCE/AI & DS	300000	150	Mär 2023
3	Amrita vishwa vidyapeetam	CISCO value added course (CCNA I & II)	faculty members- CSE/ECE/IT/CCE/AI & DS	109240	5 faculty	Mär 2023
4	RedHat Academy and Vectra Techno soft	RHCSA course	CSE/ECE/IT/CCE/AI & DS	227500	65	Dez 2022

**Request for Consultancy Project Work**

5 messages

udaya.prabhu@caecentre.com <udaya.prabhu@caecentre.com>  
To: shanmugasundar.mech@sairamit.edu.in  
Cc: info@caecentre.com

Wed, Apr 5, 2023 at 12:17 PM

Dear sir ,

Greetings from CAE CENTRE.

In continuation with our Telephonic discussion on 30/03/2023 , please find the below specified problem definition for your reference, we need consultancy to design the same , as discussed we will pay Rs 10,000/- as consultancy charges to complete the project , the same need to be submit at the earliest. Kindly confirm the same by reply mail .

**Problem Definition:****“DESIGN OF 6 DEGREES OF FREEDOM ARTICULATED ROBOT FOR WELD INSPECTION “****Requirements:**

1. CAD design
2. Sensor selection and justification
3. Design Validation
4. FEA Analysis

Thanks &amp; Regards

**M.Udaya Shankar Prabhu**

Head – Business Development

Mobile No : 9884366606

Email id : [udaya.prabhu@caecentre.com](mailto:udaya.prabhu@caecentre.com) | Website : [www.caecentre.com](http://www.caecentre.com)

No 17B/8B Grace Garden 5th Lane Royapuram Chennai – 600013

Dr. G. SHANMUGA SUNDAR <shanmugasundar.mech@sairamit.edu.in>  
To: udaya.prabhu@caecentre.com

Wed, Apr 5, 2023 at 12:22 PM

REspected sir ,

Thank you for your email regarding the consultancy work . I accept and complete this work at the earliest . Thank you once again.

[Quoted text hidden]

**With Regards**

**Dr.G.SHANMUGASUNDAR, B.E , M.E., Ph.D.,**  
**Associate Professor & Dean R&D**  
**Department of Mechanical Engineering,**  
**Sri Sai Ram Institute of Technology,**  
**Sai Leo Nagar, West Tambaram,**  
**chennai-600 044**  
**Mb.No.-+919941380398**

udaya.prabhu@caecentre.com <udaya.prabhu@caecentre.com>  
To: "Dr. G. SHANMUGA SUNDAR" <shanmugasundar.mech@sairamit.edu.in>

Thu, Apr 6, 2023 at 12:38 PM

Dear Sir,

Kindly find the payment reference no.

- Your request has been completed successfully.
- Transaction with reference number 847947654626131 is in Accepted state.

Top of Form

**NEFT Funds Transfer - Confirm**

06-04-2023 12:36:16 GMT +0530

•

UTR: N096230185674288

•

•

User Reference / Template ID:

Source Account: 1157115000024609-1157-

•

•

Beneficiary Name: SAIRAM INDUSTRIAL CONSULTANCY

Beneficiary Account: 500101013033729

•

•

IFSC Code: CIUB0000634

Bank Name: CITY UNION BANK LIMITED

•

•

Transfer amount: 10,000.00

Bottom of Form

Thanks & Regards,

Udaya Prabhu  
Head Business Development  
CAE CENTRE  
9884366606  
[Udaya.prabhu@caecentre.com](mailto:Udaya.prabhu@caecentre.com)

[Quoted text hidden]

**udaya.prabhu@caecentre.com** <udaya.prabhu@caecentre.com>  
To: "Dr. G. SHANMUGA SUNDAR" <shanmugasundar.mech@sairamit.edu.in>

Thu, Apr 6, 2023 at 10:28 PM

Dear Sir,

Greetings from CAE CENTRE.

As discussed kindly find the attached Consultancy document for your reference.

Thanks & Regards,

Udaya Prabhu  
Head Business Development  
CAE CENTRE  
9884366606  
[Udaya.prabhu@caecentre.com](mailto:Udaya.prabhu@caecentre.com)

[Quoted text hidden]

REspected sir ,

[Quoted text hidden]

[Quoted text hidden]

---

 **Dr.Shanmuga Sundaram\_Consultancy Work.pdf**  
781K

---

**Dr. G. SHANMUGA SUNDAR** <shanmugasundar.mech@sairamit.edu.in>  
To: UDAYA SHANKAR PRABHU <udaya.prabhu@caecentre.com>

Sun, Apr 9, 2023 at 6:16 PM

Thank you for your mail sir .

[Quoted text hidden]

---

**CAE CENTRE**  **ALTAIR** **image001.png**  
CHANNEL PARTNER 11K



**CAE CENTRE**

Date: 6/4/2023

TO WHOMSOEVER IT MAY CONCERN

This is to certify that Dr. **G.SHANMUGASUNDAR**, Professor, Department of Mechanical Engineering, **SRI SAI RAM INSTITUTE OF TECHNOLOGY**, Chennai -44 Completed the Following Consultancy project for **CAE CENTRE – Chennai**.

**“DESIGN OF 6 DEGREES OF FREEDOM ARTICULATED ROBOT FOR WELD INSPECTION “**

We made payment of Rs 10,000/- ( Rupees Ten Thousand only ) by means of NEFT to the name of **SAIRAM INDUSTRIAL CONSULTANCY Account** dated 06/04/2023 vide the transaction number 847947654626131.

For CAE CENTRE

*M. Udaya Prabhu*



**CAE CENTRE**

No. 17B/8B, Grace Garden 5th Lane, Royapuram, Chennai - 600 013.

Mobile No : 9884366606

[www.caecentre.com](http://www.caecentre.com) / [udaya.prabhu@caecentre.com](mailto:udaya.prabhu@caecentre.com)

**PROJECT TITLE:**

**“DESIGN OF 6 DEGREES OF FREEDOM ARTICULATED ROBOT FOR WELD INSPECTION “**

**NAME OF THE COMPANY:** CAE CENTRE , Royapuram, Chennai, Tamil Nadu 600013.

**Done by :** Dr.G. Shanmugasundar / Dept.of. Mechanical Engineering, Sri Sai Ram Institute of Technology

**MODELLING AND STATIC ANALYSIS OF T-3R-T CONFIGURATION**

The first step of FEA is to build of a CAD model for the complete structure of the robot Fanuc LR Mate 100, considering the restrictions in the joints using 3D solid modelling software – SolidWorks 2018. In order to perform a static analysis a FEM based software has been used – Ansys 12.0 – Fig. 1 and Fig. 2

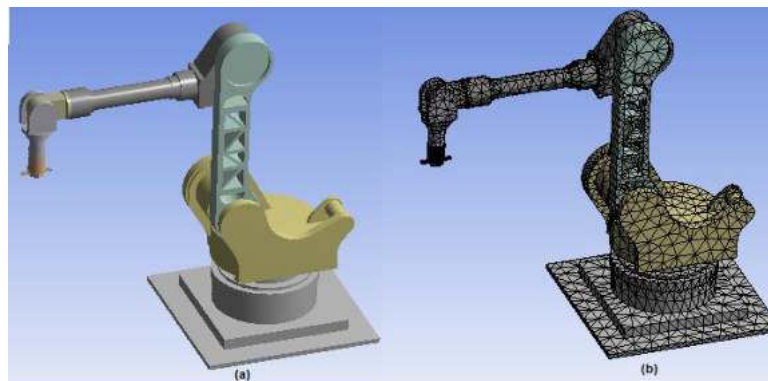
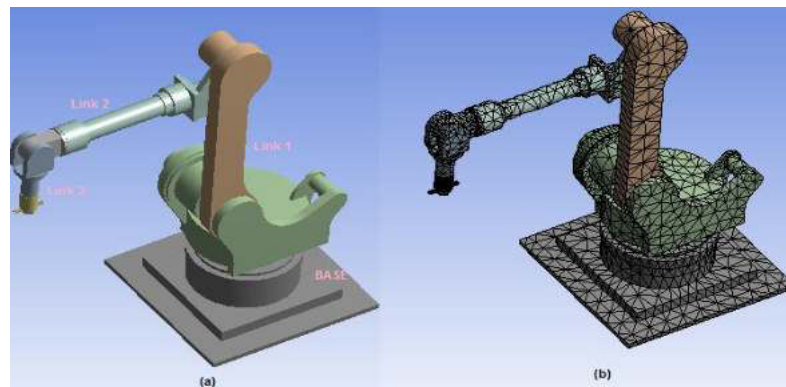

For the FEM analysis of the robot structure, we considered as input data the following parameters: distributed loads  $O_x$ ,  $O_y$ ,  $O_z$  of 50kg ~ 490N gripper load and a temperature distribution in the working area of 50 ° C. The structure was tested to a static analysis in order to obtain the total deformation and directions of principal stress and equivalent (von-Mises).

**Results and discussions**

The structure was tested to a static analysis in order to obtain the total deformation and directions of principal stress and equivalent (von-Mises) at constant loading condition for three different materials. The properties of three different materials of the arm are shown in the table. In figure three shows the meshing of the model for the robot mechanism (3).

Table 1. Material properties

Sl no	Properties	Structural Steel	Aluminium alloy	Stainless steel
1	Density ( kg/m <sup>3</sup> )	7,800	2,700	8,000
2	Thermal Expansion (µm/m-K)	11	31	9.6
3	Specific Heat (kJ/kg-K)	0.48	0.896	0.500
4	Thermal Conductivity (W/m-K)	50	167	16.2
6	Young's Modulus (Gpa)	200	68.9	193
7	Poisson's Ratio	0.260	0.33	0.29
8	Bulk Modulus (Gpa)	140	70	134
8	Shear Modulus (Gpa)	79.3	26	72
9	Ultimate tensile strength ( Mpa)	510	310	505

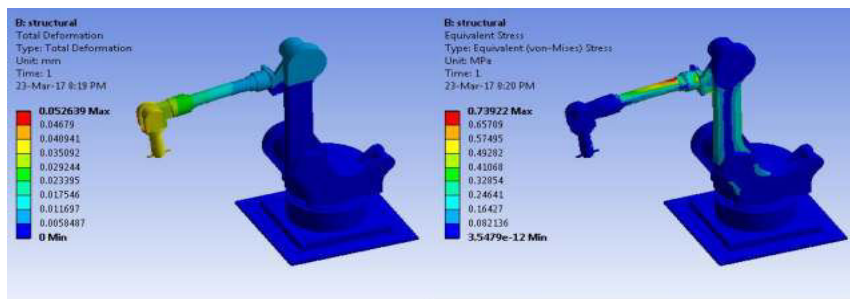

STRUCTURAL STEEL

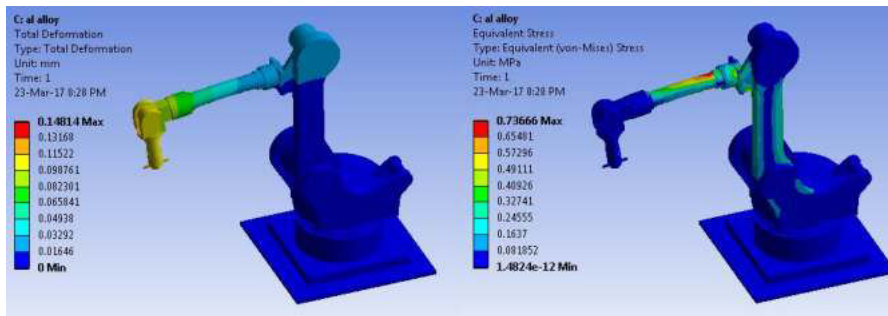

Aluminum Alloy



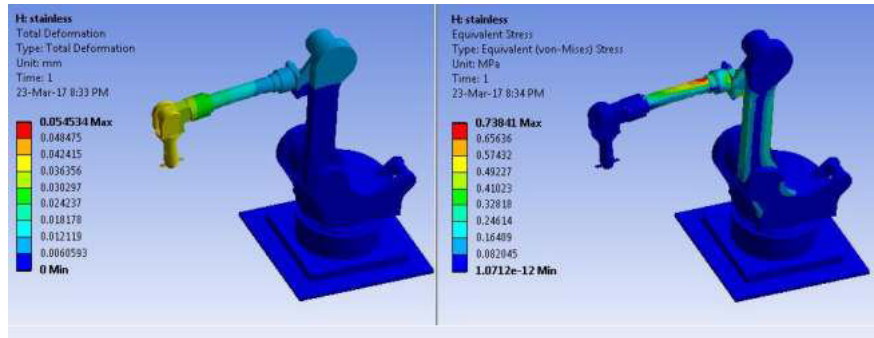

Stainless steel

The final optimization step depends on the criteria to be improved, which sets the parameters for analysis. Analysis of parameters like deformation, stiffness or frequency must be considered in order to optimize the robot model.

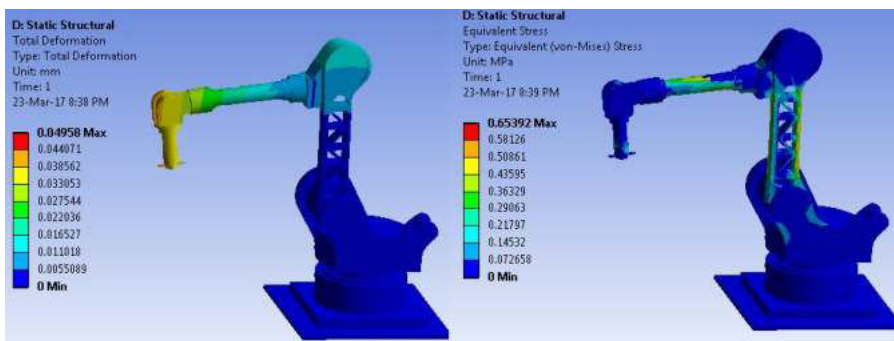

STRUCTURAL STEEL

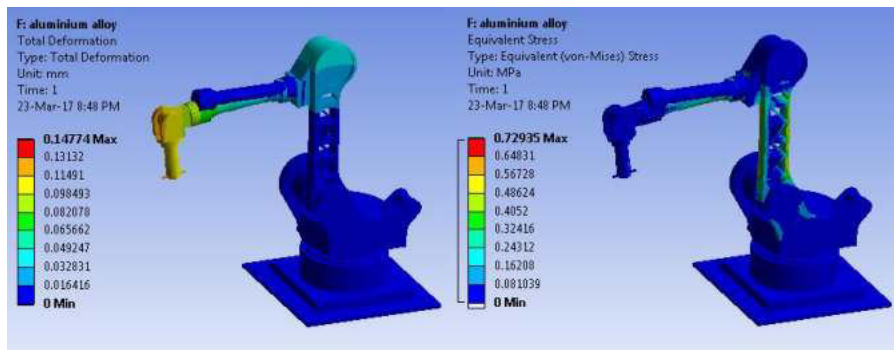

Aluminum Alloy

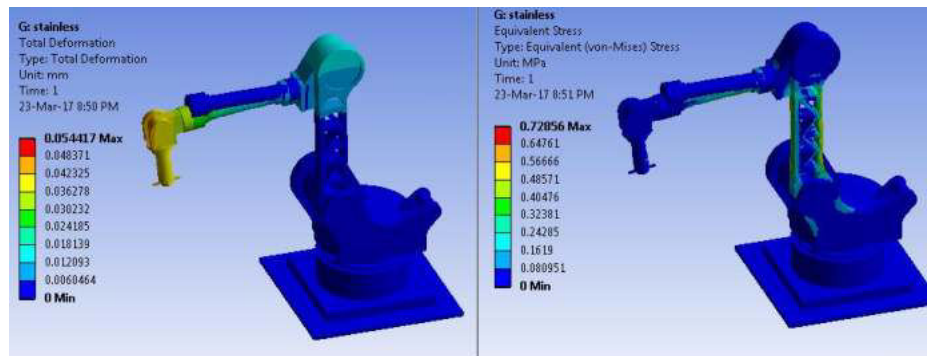

Stainless steel

A comparison between several shapes of the structure has been done. The first analysis comprises a possible shape – Fig. . For this, the results are mentioned in Table 4 – the equivalent von-Mises stress and Table – the deformations along the three axis.

Table 2. Software results for Deflection and stress values of the three materials

<b>SOLID TYPE</b>	<b>mm</b>	<b>Mpa</b>	<b>No Unit</b>
	<b>TOTAL DEFORMATION</b>	<b>STRESS</b>	<b>STRAIN</b>
STRUCTURAL STEEL	0.0526	0.7392	4.72E-06
ALUMINIUM ALLOY	0.14814	0.7366	1.33E-05
STAINLESS STEEL	0.0545	0.7384	4.90E-06
<b>FRAME TYPE</b>			
	<b>mm</b>	<b>Mpa</b>	<b>No Unit</b>
	<b>TOTAL DEFORMATION</b>	<b>STRESS</b>	<b>STRAIN</b>
STRUCTURAL STEEL	0.04958	0.6539	4.90E-06
ALUMINIUM ALLOY	0.14774	0.7293	1.03E-05
STAINLESS STEEL	0.0544	0.7285	3.78E-06

### Project Feasibility :

The current research aimed to reduce the weight of the structure, minimizing its structural deformations on directions Ox, Oy, Oz in order to improve the stiffness, on the basis of calculus of the loading forces applied in a static study. The suggested variants may be chosen from better shape, weight, stiffness, static and dynamic behaviour. Therefore the paper provides a methodology of analysis on the criteria of stiffness and mass while the static analysis determines a solution for a part of the arm that has been detailed. An optimization of a part of the structure from these points of view was performed and we have established the first analysis leading the best results. Research methodology was developed to validate the theoretical results obtained by numerical analysis, finite element method (both those related to static analysis), the frequency modes and the optimization. We have to point out that the design elements of the structure should carefully avoid discontinuities, variations in thickness, sudden changes of direction, small diameter holes and especially sharp angles in order to avoid concentration of stresses. An improvement of the static behaviour of the elements of the structure led to finding a constructive solution from the point of view of optimum weight, shape and static stiffness with changes imposed by successive loads and choosing the best option. Design objective is to find the form that provides maximum stiffness for a given mass. Its structural shape optimization requires a considerable computing time, many trials, is very dependent on user experience rather than solve a local problem and can only improve certain aspects of structural behaviour. Topological optimization is a technique to determine the spatial pattern of its structure or to establish optimum generalized form of continuous or composite structures. Topological optimization to obtain optimum generalized form of a structure is one of the priority areas of implementing the new techniques. The goal is to find the best use of the material for a structure subjected to the action of a force or more forces distribution. From this perspective the aim of the topological optimization for structure design elements is to achieve a maximum rigidity and to optimize the topology with the mass control criteria and interference between the different composite materials.

Course	<b>CCNA 1 – Introduction to Networks (ITN ) &amp; CCNA 2 – Switching, Routing, and Wireless Essentials (SRWE)</b>
Venue	Online mode – On Webex platform
Duration	<b>17/04/2023 (Monday) to 04/05/2023 (Thursday)</b>
Training charges	<b>Rs. 18,600 + GST 18% per Instructor (For both modules put together)</b>
Payment mode	Based on registrations, Proforma Invoice shall be sent, and payment can be done online through the link provided in the Proforma Invoice.
Invoicing	Provide complete Billing Address including GST Number If available.
Registration	Register at <a href="https://forms.office.com/r/HW43r0AtkQ">https://forms.office.com/r/HW43r0AtkQ</a> . Last Date : 07/04/2023
Expected registration details	<ul style="list-style-type: none"> <li>• Name of the Academy and full address</li> <li>• Name of the Participant with Gender, E-mail address and Mobile number</li> <li>• User name in Cisco NetAcad</li> </ul> <b>No registrations will be accepted without the NetAcad Username</b>
Contact persons	Mr. Sreevalsan M., NetAcad Contact :      +91-422-2685000 Extn. 5333 sree@amrita.edu
	Mrs. M. Kohila, NetAcad Instructor :      +91--422-2685000 Extn. 5342 l_kohila@cb.amrita.edu
Important notes	<ul style="list-style-type: none"> <li>• All participants need to have a decent internet connectivity to have a satisfying experience.</li> <li>• All participants need to have a microphone for interacting with the instructor.</li> <li>• For the evaluation process, a webcam is mandatory.</li> <li>• All participants should be present for all the session.</li> <li>• Training is feasible only with minimum 5 participants.</li> </ul>

<http://netacad.com>





**SRI SAIRAM INSTITUTE OF TECHNOLOGY, CHENNAI - 44**

**Admn. Office, T.Nagar, Chennai - 17.**

No. 19/SIT/TBM/TR.PR/2023

Dated: 30.06.2023

Sub: SIT, TBM - Administration - Training Program on Advanced J2EE + Soft Skills for final year girl students of various Departments - Permission Granted - Orders issued.

Ref: Letter No. 139/S2/SSIT, Ch-44/1371/2023. Dated 26.06.2023 from the Principal.

**ORDER:**

The Principal has been permitted to conduct Training Program on "**ADVANCED J2EE + SOFT SKILLS**" in association with ICT Academy as initiative of Capgemini through our **Information Technology** Department for **Final Year Girl students - 60 Nos. (as per list enclosed) for CSE/ECE/IT/CCE/AI&DS Departments** in our college campus at Hands on Session Room, B - Block, SEC from **03.07.2023 (Total 420 Hours)**.

The Principal is also been permitted to conduct the "**Inaugural Program**" on 03.07.2023 - as requested in the reference cited.

For SRI SAIRAM INSTITUTE OF TECHNOLOGY,  
(Sd/xxxxxxxx)

CHIEF EXECUTIVE OFFICER

/ By order of Chief Executive Officer /

EXECUTIVE DIRECTOR

Encl: Students list

To:

The Principal,  
Sri Sairam Institute of Technology,  
Chennai-44.

> Chief Information Officer, SGI

Copy to:

> Accounts Section.

1108 / I. T. / 0806 / A.I.D.S

SRI SAIRAM INSTITUTE OF TECHNOLOGY  
bbo  
17 MAR 2023

**SRI SAIRAM INSTITUTE OF TECHNOLOGY, CHENNAI - 44**

**Admn. Office, T.Nagar, Chennai - 17.**

Dated: 16.03.2023

No. 19/SIT/TBM/CCNA COURSE/2023

Sub: SIT, TBM - Administration - Organising CISCO CCNA Course for our Students of various Departments through CSE Department - Permission Granted.

Ref: Letter No. 040/S2/616/SSIT, Ch-44 /2023. Dated 14.03.2023 from the Principal.

**ORDER:**

The Principal has been permitted to organise CISCO Value-Added Course - (CCNA-I& II) for our 150 Students (as per list enclosed) of CSE/ECE/AIDS/CCE/IT Departments in our College Campus.

Principal has been permitted to collect Rs.2000/- (Rupees Two Thousand Only) as 'Course Fee' from each Student - Participant, as requested in the reference cited.

For SRI SAIRAM INSTITUTE OF TECHNOLOGY,

(Sd/xxxxxxxx)

CHIEF EXECUTIVE OFFICER

/ By order of Chief Executive Officer /

EXECUTIVE DIRECTOR 1/3

Encl: Students list.

To: ✓ The Principal.  
Sri Sairam Institute of Technology,  
Chennai-44.

Copy to: > Accounts Section.

copy to: WOD/CSE  
ir A/c



# SAI RAM INSTITUTE OF TECHNOLOGY

An Autonomous Institution | Affiliated to Anna University & Approved by AICTE, New Delhi  
Accredited by NBA and NAAC 'A+' | An ISO 9001:2015 Certified and MHRD NIRF ranked institution  
Sai Leo Nagar, West Tambaram, Chennai - 600 044 www.sairamit.edu.in



Ref: T.O.No:034/S2/586/SSIT/Ch-44/2023

Date: 10.03.2023

## Submitted to the Chairman

Sub: SSIT, Chennai – 44 – Requisition to organize Cisco Academy-  
CCNA-I & II value added course is based on Train the Trainer Model  
with students from CSE, IT, ECE, AI&DS, CCE and EEE students -  
and 5 faculty members - Permission – Requested – Reg.

Ref: Letter dt. 10.03.2023 received from the HoD., / Department of CSE.

\*\*\*\*\*

A copy of the letter received from the HoD., CSE is submitted herewith for kind perusal of the Chairman.

It is submitted that the HOD., CSE has stated in her letter cited that the Department has organized Cisco Academy-CCNA-I (Cisco Certified Network Administrator-I & II) certification in association with Amrita Vishwa Vidyapeetham, Coimbatore for the past 4 years. The value added course is based on Train the Trainer model with the students from CSE, IT, ECE, AI&DS, CCE and EEE. Every year Amrita Vishwa Vidyapeetham is organizing CCNA-I and II course for the faculty of Engineering Colleges who in turn train the students on CCNA for better future in Networking.. In this connection, it is submitted that Amrita Vishwa Vidyapeetham is organizing CCNA-I & II certification training from 17.04.2023 to 04.05.2023 through online mode (webx) @ Rs.18600/- + GST 18% per instructor. Therefore, it is requested that permission may kindly be granted to conduct the above program in our Institution and the following faculty members may be permitted to register for the above course and sanction may also be accorded for 6 faculty as certification from their SPACE amount.

1. Dr.V.Brindha Devi / HoD / IT
2. Mr.J.Thirunavukkarasu/AP/CSE
3. Ms.P.Subha/AP/IT
4. Ms.L.Kannagi, AP/CCE
5. Mr.J.Jeyaganesan/AP/AI&DS
6. Ms.R.Lakshmi Devi/AP/ECE

Submitted to the Chairman for kind perusal and approval

encl: as above

  
13/3



PRINCIPAL  
PRINCIPAL

SRI SAI RAM INSTITUTE OF TECHNOLOGY  
SAI LEO NAGAR, CHENNAI-600 044.





# Sri SAI RAM INSTITUTE OF TECHNOLOGY

(Managed by Sathagiri Educational Trust, Chennai - 17)

Accredited by **NBA** and **NAAC "A+"** | An ISO 9001:2015 Certified and MHRD NIRF ranked institution

Sai Leo Nagar, West Tambaram, Chennai. Tel : 044 - 2251 2111 . [www.sairamit.edu.in](http://www.sairamit.edu.in)

Founder Chairman : MJF. Ln. Leo Muthu

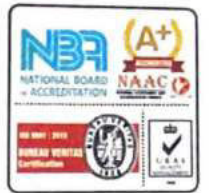

18.04.2023

To

The Chief Executive Officer,  
Foyer Technology Pvt. Ltd.  
Greta Towers, Industrial Estate  
Perungudi, Chennai-600096

Respected Sir,

Sub: - Invoice for UI design in React for CRM Farm-Consultancy.

\*\*\*\*\*

With reference to above subject matter the team of 5 students

1. Mr. Anirudh. P Menon
2. Mr. Harish IJ
3. Jaya Durga
4. Danush
5. Shanker Narayanan

under the guidance of Dr. B. Sreedevi and Mr. M. Parthiban have completed the UI design as per the requirements of Foyer Technology Pvt. Ltd. Hence we request that an amount of Rs. 37500/- (THIRTY SEVEN THOUSAND FIVE HUNDRED ONLY) may be sanctioned for the consultancy work rendered.

#### BANK DETAILS FOR TT REMITTANCE

NAME: CITY UNION BANK

ACCOUNT NO(15 DIGIT): 500101013033729

IFSC : CIUB0000634

ACCOUNT TYPE : CUB SAVINGS A/C OTHERS

CUSTOMER DETAILS : SAIRAM INDUSTRIAL CONSULTANCY

SRI SAIRAM INSTITUTE OF TECHNOLOGY

SAI LEO NAGAR, POONTHANDALAM,

BEHIND LEO COMPLEX T NAGAR

CHENNAI 600017



  
Dr. K. PALANI KUMAR  
PRINCIPAL

SRI SAIRAM INSTITUTE OF TECHNOLOGY  
SAI LEO NAGAR, CHENNAI-600 044.



Admn Office : "SAI BHAVAN", #31 B, Madley Road, T. Nagar, Chennai - 600 017.

Tel : 044 - 4226 7777 e-mail : [sairam@sairamgroup.in](mailto:sairam@sairamgroup.in)

 /SairamInstitutions

 +91 98848 45678

**Sairam**  
INSTITUTIONS 

[www.sairamgroup.in](http://www.sairamgroup.in)

# Hakate Technologies PVT LTD

CIN: U72200TG2017PTC117610

Registered Address: 2-114, SHANTHI NAGAR,  
VANASTHALIPURAM POST, KALVANCHA,  
HYDERABAD, RANGAREDDI, TELANGANA, INDIA 500070.



To  
Dr. S. Vidya

Date: October 07, 2022

Assistant Professor

Department of CSE

Sri Sai Ram Institute of Technology

Sai Leo Nagar, Chennai - 600044

## Project Completion Certificate

### TO WHOMSOEVER IT MAY CONCERN

This is to certify that Dr. **S. Vidya**, Assitant Professor of Sri Sai Ram Institute of Technology, Chennai, has successfully completed the **Service Oriented Architecture** consultancy projects at Edwisely for the duration of 1 month starting from **August 31, 2022** to **September 30, 2022**.

During the above period, she has significantly contributed to the creation and development of content. We are highly satisfied with her work.

Thanking you,

Yours Truly,

For Edwisely

A handwritten signature in cursive script that reads "Satishkumar".

**Satish Kumar**

Human Resources



## View Transaction Details

### General Transaction Details

Beneficiary Type: Ad hoc Personal Payee

Amount: ₹ 13,000.00

Transaction Date (DD/MM/YYYY): 05/08/2022

Remarks: Consultant Hakate Tech

Channel Reference ID: 2636478817

Transaction Status: Success

UTR No : NEFTRATNN22217059533

Beneficiary Account: 500101013033729

Frequency Type: One Time

Pay From Account: HAKATETECH

Transaction Type: NEFT

### Amount & Frequency Details

Total Amount: ₹ 13,000.00

Next Authorizer: No More Approval Required

Transaction Currency: ₹

PO Number: 000264700680



भारत सरकार  
Government of India  
सूक्ष्म, लघु एवं मध्यम उद्यम मंत्रालय  
Ministry of Micro, Small and Medium Enterprises



## UDYAM REGISTRATION CERTIFICATE



Our small hands to  
make you LARGE

UDYAM REGISTRATION NUMBER	UDYAM-TN-08-0040754																							
NAME OF ENTERPRISE	DEVUPS APPLIED ENGINEERING SOLUTIONS																							
TYPE OF ENTERPRISE *	MICRO ( Based on FY 2020-21 )																							
MAJOR ACTIVITY	SERVICES (Trading)																							
SOCIAL CATEGORY OF ENTREPRENEUR	GENERAL																							
NAME OF UNIT(S)	<table border="1"><thead><tr><th>S.No.</th><th colspan="3">Name of Unit(s)</th></tr></thead><tbody><tr><td>1</td><td colspan="3">DevUPS Fullstack</td></tr></tbody></table>				S.No.	Name of Unit(s)			1	DevUPS Fullstack														
S.No.	Name of Unit(s)																							
1	DevUPS Fullstack																							
OFFICAL ADDRESS OF ENTERPRISE	<table border="1"><thead><tr><th>Flat/Door/Block No.</th><th>IE3501</th><th>Name of Premises/ Building</th><th>Sri Sai Ram Institute of Technology</th></tr></thead><tbody><tr><td>Village/Town</td><td>Sai Leo Nagar</td><td>Block</td><td>Second Floor</td></tr><tr><td>Road/Street/Lane</td><td>West Tambaram</td><td>City</td><td>Chennai</td></tr><tr><td>State</td><td>TAMIL NADU</td><td>District</td><td>KANCHIPURAM , Pin 600045</td></tr><tr><td>Mobile</td><td>9444245253</td><td>Email:</td><td>sreedevi.balasubramanian@gmail.com</td></tr></tbody></table>				Flat/Door/Block No.	IE3501	Name of Premises/ Building	Sri Sai Ram Institute of Technology	Village/Town	Sai Leo Nagar	Block	Second Floor	Road/Street/Lane	West Tambaram	City	Chennai	State	TAMIL NADU	District	KANCHIPURAM , Pin 600045	Mobile	9444245253	Email:	sreedevi.balasubramanian@gmail.com
Flat/Door/Block No.	IE3501	Name of Premises/ Building	Sri Sai Ram Institute of Technology																					
Village/Town	Sai Leo Nagar	Block	Second Floor																					
Road/Street/Lane	West Tambaram	City	Chennai																					
State	TAMIL NADU	District	KANCHIPURAM , Pin 600045																					
Mobile	9444245253	Email:	sreedevi.balasubramanian@gmail.com																					
DATE OF INCORPORATION / REGISTRATION OF ENTERPRISE	10/05/2022																							
DATE OF COMMENCEMENT OF PRODUCTION/BUSINESS	10/05/2022																							
NATIONAL INDUSTRY CLASSIFICATION CODE(S)	<table border="1"><thead><tr><th>SNo.</th><th>NIC 2 Digit</th><th>NIC 4 Digit</th><th>NIC 5 Digit</th><th>Activity</th></tr></thead><tbody><tr><td>1</td><td>62 - Computer programming, consultancy and related activities</td><td>6209 - Other information technology and computer service activities</td><td>62099 - Other information technology and computer service activities n.e.c</td><td>Services</td></tr></tbody></table>				SNo.	NIC 2 Digit	NIC 4 Digit	NIC 5 Digit	Activity	1	62 - Computer programming, consultancy and related activities	6209 - Other information technology and computer service activities	62099 - Other information technology and computer service activities n.e.c	Services										
SNo.	NIC 2 Digit	NIC 4 Digit	NIC 5 Digit	Activity																				
1	62 - Computer programming, consultancy and related activities	6209 - Other information technology and computer service activities	62099 - Other information technology and computer service activities n.e.c	Services																				
DATE OF UDYAM REGISTRATION	16/06/2022																							

\* In case of graduation (upward/reverse) of status of an enterprise, the benefit of the Government Schemes will be availed as per the provisions of Notification No. S.O. 2119(E) dated 26.06.2020 issued by the M/o MSME.

Disclaimer: This is computer generated statement, no signature required. Printed from <https://udyamregistration.gov.in> & Date of printing:- 16/06/2022

For any assistance, you may contact:

1. District Industries Centre: KANCHIPURAM (TAMIL NADU)

2. MSME-DI: CHENNAI (TAMIL NADU)

BE A  
CHAMPION  
with the  
Ministry of



**SRI SAIRAM INSTITUTE OF TECHNOLOGY, CHENNAI - 44**

**Admn. Office, T.Nagar, Chennai - 17.**

No. 19/SIT/TBM/RHCSA /2022

Dated: 19.12.2022

1840  
21/12

Sub: SIT, TBM - Administration - Commencement of RHCSA in our college  
Campus - Provide training program for students of various departments  
- Permission Granted.

Ref: Letter No. 312/S2/SSIT, Ch-44 /2022/2462. Dated 17.12.2022 from the  
Principal.

**ORDER:**

The Principal has been permitted to start "**RED HAT ACADEMY**" in our college campus to organise Training Program through by Red Hat Certified Instructor from Vectra Techno Soft Private Ltd for 65 Students (as per list enclosed) of CSE/ECE/IT/CCE/AIDS Departments from 22.12.2022 (Total 45 Hours).

Principal has been permitted to collect a sum of Rs. 3,500/- from each willing student as "**Training Fee**" for the above purpose - as requested in the reference cited.

For SRI SAIRAM INSTITUTE OF TECHNOLOGY,  
(Sd/xxxxxxxx)  
**CHIEF EXECUTIVE OFFICER**

/ By order of Chief Executive Officer /

  
**EXECUTIVE DIRECTOR 1/f**

**nci: Students list**

- ✓ The Principal.  
Sri Sairam Institute of Technology,  
Chennai-44.
- Chief Information Officer, SGEI
- Dean, TAP Cell, SEC, Ch-44

Copy to:  
➤ Accounts Section.

File: HOD / e se  
" : A/c 8857

From

The Managing Director  
MICRON PRECISION TOOLS,  
44, Vallalar Street,  
Jagathambigai Nagar,  
Padi, Chennai-50

To

Mrs.G.Ezhilarasi,  
Associate Professor  
Department of EEE,  
Sri Sai Ram Institute of Technology,  
West Tambaram  
Chennai-600044.

Madam

Sub: Consultancy Work: Reg

With reference to your letter Ref No: SSIT/EEE/CON/2022-23/02 made with our company we are pleased to update that we offer our company-based project titled “Fibre Optic Sensor for Measurement of Surface Properties”. The amount spent as per your budget that must be relating to the project only. Honorarium will be paid for the project after successful completion.

Yours Sincerely,

The Managing Director  
MICRON PRECISION TOOLS,  
44, Vallalar Street,  
Jagathambigai Nagar,  
Padi, Chennai-50.

- Inbox** 12,706
- Starred
- Snoozed
- Important
- Sent
- Drafts** 147
- Categories
- Social** 379
- Updates** 5,252
- Forums** 2,091
- Promotions** 3,405
- More
- Labels** +
- Appraisal
- crit-4
- Follow up



**MICRON PRECISION TOOLS** <micronprecisiontools@yahoo.com>  
to me ▾

Dear madam,

kindly find our request letter for consultancy work.

Regards ,

**K.KANNAN**  
**Managing Director**  
**9444141843**

**MICRON PRECISION TOOLS**  
An ISO 9001-2015 Certified Company  
NO: 44A, Vallalar Street, Jagathambigai Nagar,  
Padi, Chennai-600050  
Mobile : 9444141843 / 9940635488 / 9940141843  
E-mail- [micronprecisiontools@yahoo.com](mailto:micronprecisiontools@yahoo.com)

From

27.2.2023

The Managing Director  
MICRON PRECISION TOOLS,  
44, Vallalar Street,  
Jagathambigai Nagar,  
Padi, Chennai-50

To

Mrs.G.Ezhilarasi,  
Associate Professor  
Department of EEE,  
Sri Sai Ram Institute of Technology,  
West Tambaram  
Chennai-600044.

Sir

**Sub:** Fibre Optic Sensor for Measurement of Surface Properties –Consultancy –Amount Sanction – Regarding.

With reference to above subject matter we sanction 30000/-Rs (Thirty thousand only) for the consultancy work purpose. We expect work should finish on time. Following are enclosed herewith for your information and further working.

**Project Requirements:**

A design for a fiber optic sensor achieving two dimensional representation of a surface is needed. The simple operating principle is similar to that of a barcode reader or photoelectric sensor receiving and transmitting fibers are in the same plane at equal incident angles to a surface collected radiation is conveyed to a PIN photodiode and preamplifier was needed. If sensed voltage exceeds a predetermined cut-off level, the sensor concludes the presence of a surface thus enabling the detection of through holes in a plate or the edge of a plate.

Thanking You

The Managing Director  
MICRON PRECISION TOOLS.





- Inbox** 12,706
- Starred
- Snoozed
- Important
- Sent
- Drafts** 147
- Categories
- Social** 379
- Updates** 5,252
- Forums** 2,091
- Promotions** 3,405
- More
- Labels** +
- Appraisal
- crit-4
- Follow up



**MICRON PRECISION TOOLS** <micronprecisiontools@yahoo.com>  
to me ▾

Dear madam,

kindly find our request letter for consultancy work.

Regards ,

**K.KANNAN**  
**Managing Director**  
**9444141843**

**MICRON PRECISION TOOLS**  
An ISO 9001-2015 Certified Company  
NO: 44A, Vallalar Street, Jagathambigai Nagar,  
Padi, Chennai-600050  
Mobile : 9444141843 / 9940635488 / 9940141843  
E-mail- [micronprecisiontools@yahoo.com](mailto:micronprecisiontools@yahoo.com)



A/c Payee

बैंक ऑफ इंडिया  
Bank of India



चेन्नई शाखा, चेन्नै, तमिलनाडु - 600001  
CHENNAI BRANCH, CHENNAI TAMIL NADU - 600001  
IFSC : BKID0006000

उत्पत्ति वर्ष की तारीख से 3 माह के लिए वैध - VALID FOR 3 MONTHS FROM THE DATE OF ISSUE

1 3 0 3 2 0 2 3  
D D M M Y Y Y Y  
S3792

Pay SAIRAM INDUSTRIAL CONSULTANCY

या धारक को Or Bearer

रुपये Rupees Thirty Thousand Only

अदा करें।

₹

\*\*30,000.00

खा. सं. 800020110001037  
A/c No.

चेक धारक की आधार संख्या (वैकल्पिक) Cheque receiver's AADHAAR number (optional)

Grid for AADHAAR number

K-G

R. Anky

हमारी सभी शाखाओं पर समतुल्यता में देय PAYABLE AT ALL OUR BRANCHES IN CLEARING

MICRON PRECISION TOOLS  
Please sign above

⑈487721⑈ 600013009⑈ 017840⑈ 11

UTILITY FORMS PVT. LTD. / CTS - 2610 21112002 1007721



Dhanasekar R &lt;dhanasekar.eee@sairamit.edu.in&gt;

---

**Sub: Consultancy Work regarding**

5 messages

---

**Dhanasekar R** <dhanasekar.eee@sairamit.edu.in>  
To: qualityelectricalworks@gmail.com

Sat, Feb 25, 2023 at 11:27 AM

Ref No : SSIT/EEE/CON/2022-23/05

Sir,

Sub: Consultancy Work regarding.

I am writing to apply for any project or consultancy work in your esteemed industry as my current research area suits your industry needs. Currently I am working as Associate Professor in EEE department at Sri Sai Ram Institute of Technology.

I am doing research work in 'Design and Implementation of speed control of DC drives with Intelligent controller'.

I feel strongly that I would be an ideal candidate for your position of consultation work at your industry. I possess the skills necessary to meet expectations and to satisfy your needs.

I welcome the opportunity to do this project for your industry, and look forward to hearing from you.

Sincerely

R.DHANASEKAR  
Associate Professor,  
Department of EEE,  
Sri Sai Ram Institute of Technology,  
West Tambaram,  
Chennai- 600044.  
9994602074

---

**Murugarajan S** <qualityelectricalworks@gmail.com>  
To: Dhanasekar R <dhanasekar.eee@sairamit.edu.in>

Mon, Feb 27, 2023 at 5:26 PM

Sir,

**Sub: Consultancy Work -Reg,**With reference to your letter Ref No : **SSIT/EEE/CON/2022-23/05** made with our company .We are pleased to inform you that we offer our company based project titled  
**"speed control of DC Motor using Arduino under various load torques"**

The amount spent as per your budget that must be relating to the project only.

Honorarium will be paid for the project after successful completion of the project.

Thanking you,

Yours Sincerely,

Regards,

S.Murugarajan,  
Quality electrical works,  
pl.no7,vasanthapuri ,phase-1,  
north malayambakkam,chennai-600123,  
9551274627,qualityelectricalworks@gmail.com

[Quoted text hidden]

**Dhanasekar R** <dhanasekar.eee@sairamit.edu.in>  
To: Murugarajan S <qualityelectricalworks@gmail.com>

Tue, Mar 7, 2023 at 9:51 PM

To  
S.Murugarajan,  
Quality electrical works,  
pl.no7,vasanthapuri ,phase-1,  
north malayambakkam,chennai-600123,

Sir  
Sub: Submission of Project Closure Report: reg

This is to inform you that the project Titled "**Speed control of DC Motor using Arduino under various load torques**" has been completed on 06.03.2023. The Project has fully achieved its objectives and technical goals for the purpose. I will submit the detailed report within one week. I thank you for giving me this opportunity.

Yours Sincerely,  
R.Dhanasekar  
Associate Professor  
Department of EEE,  
Sri Sai Ram Institute of Technology,  
West Tambaram  
Chennai-600044.

[Quoted text hidden]

---

**Murugarajan S** <qualityelectricalworks@gmail.com>  
To: Dhanasekar R <dhanasekar.eee@sairamit.edu.in>

Sat, Mar 11, 2023 at 9:32 AM

Dear sir ,  
Your project is 100% completed . So I will pay for your account .Please check your account .Thank you for your support .  
Thank You,

[Quoted text hidden]

[Quoted text hidden]

---

 **Initiate Single Entry Payment Summary (33).pdf**  
110K

---

**Dhanasekar R** <dhanasekar.eee@sairamit.edu.in>  
To: Murugarajan S <qualityelectricalworks@gmail.com>

Sat, Mar 11, 2023 at 2:05 PM

Thanks Sir. Amount Received.

R.Dhanasekar  
[Quoted text hidden]

---

**JSK Labs - Request letter - Consultancy work**

4 messages

---

**Vijayaraja L** <vijayaraja.eee@sairamit.edu.in>  
To: jsklab783@gmail.com, jesu783@gmail.com  
Cc: vijaylogu\_83@yahoo.com

Mon, Feb 20, 2023 at 12:33 PM

Dear Sir,

As per our conversation I am attaching the Request letter to undertake the Consultancy work from your esteemed organization.

I am writing to apply for any project or consultancy work in your esteemed industry as my current research area suits your industry needs. Currently I am working as Assistant Professor in the EEE department at Sri Sai Ram Institute of Technology. I have been doing research for the past 10 years. My friendly personality is an asset to building relationships with clients.

I am adept at solving problems and I feel strongly that I would make an ideal candidate for your open position of Consultant at your Industry. As a high energy personable and reliable professional I possess the skills necessary to meet expectations and to satisfy your needs. I welcome the opportunity to do any projects that you require for your needs and look forward to hearing from you.

Thank you so much for your time and for any consideration you may provide me.

Thank you,  
Vijayaraja L

---

**2 attachments****JSK Labs - Reuqest letter - Consultancy work.pdf**  
11K**Vijayaraja L\_FACULTY\_PROFILE\_2022.pdf**  
508K

---

**jesu rajan** <jesu783@gmail.com>  
To: Vijayaraja L <vijayaraja.eee@sairamit.edu.in>

Fri, Mar 10, 2023 at 12:32 PM

dear sir,

With reference to your letter Ref No: SSIT/EEE/CON/2022-23/03 made with our company we are pleased to update that we offer our company-based project titled "Multilevel Inverter for Renewable Energy Integration". The amount spent as per your budget that must be relating to the project only. Honorarium will be paid for the project after successful completion.

[Quoted text hidden]

--

--

**Thanks & Regards**

**M. Jesurajan**  
**JSK Lab Instruments**  
**Chennai**  
**7667134364**

---

**Vijayaraja L** <vijayaraja.eee@sairamit.edu.in>  
To: jesu rajan <jesu783@gmail.com>

Sun, Mar 12, 2023 at 8:57 PM

Dear Sir,

Thanks for the opportunity provided to me.

I have started working on our project titled “Multilevel Inverter for Renewable Energy Integration” and half of the experimentation work has been completed now.

The entire work will be completed by next week, sir.

Thank you,  
Vijayaraja L,  
Associate Professor,  
Electrical and Electronics Engineering,  
Sri Sai Ram Institute of Technology,  
Chennai - 44.

[Quoted text hidden]

---

**Vijayaraja L** <vijayaraja.eee@sairamit.edu.in>  
To: jesu rajan <jesu783@gmail.com>

Sat, Mar 18, 2023 at 4:08 PM

Dear Sir,

Thanks for the opportunity provided to me.

I have completed your company-based project titled “Multilevel Inverter for Renewable Energy Integration” offered to me.

I will bring the experimental setup to your organization tomorrow sir.

Thank you,  
Vijayaraja L,  
Associate Professor,  
Electrical and Electronics Engineering,  
Sri Sai Ram Institute of Technology,  
Chennai - 44.

On Fri, Mar 10, 2023 at 12:32 PM jesu rajan <jesu783@gmail.com> wrote:

[Quoted text hidden]

---

**Receipt of Honorarium payment**

1 message

**JSKLAB INSTRUMENTS** <jsklab783@gmail.com>

Wed, Mar 29, 2023 at 3:23 PM

To: "vijayaraja.eee@sairamit.edu.in" &lt;vijayaraja.eee@sairamit.edu.in&gt;

Dear Sir,

With reference to your letter Ref No: SSIT/EEE/CON/2022-23/03 made with our company we are satisfied with the work you have made on the project titled "Multilevel Inverter for Renewable Energy Integration". The amount spent for the experimental work is paid as Honorarium.

Once again thanks for the work and find the Honorarium paid receipt (Rs. 30,000/-) for your reference.

--

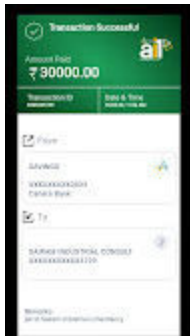
**Thanks & Regards****M. Jesurajan****JSK Lab Instruments****Chennai****7667134364****Payment receipt.jpg**

35K

---

## Receipt of Honorarium payment

1 message

---

**JSKLAB INSTRUMENTS** <jsklab783@gmail.com>

Wed, Mar 29, 2023 at 3:23 PM

To: "vijayaraja.eee@sairamit.edu.in" <vijayaraja.eee@sairamit.edu.in>

Dear Sir,

With reference to your letter Ref No: SSIT/EEE/CON/2022-23/03 made with our company we are satisfied with the work you have made on the project titled "Multilevel Inverter for Renewable Energy Integration". The amount spent for the experimental work is paid as Honorarium.

Once again thanks for the work and find the Honorarium paid receipt (Rs. 30,000/-) for your reference.

--

**Thanks & Regards**

**M. Jesurajan**

**JSK Lab Instruments**

**Chennai**

**7667134364**

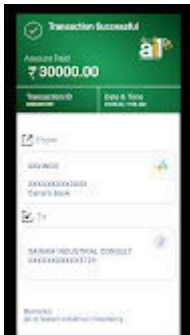

**Payment receipt.jpg**

35K



## Transaction Successful



Amount Paid

₹ 30000.00

Transaction ID

8406325199

Date & Time

25-03-23, 11:54 AM



From

SAVINGS



XXXXXXXXXX0033

Canara Bank



To

SAIRAM INDUSTRIAL CONSULT



XXXXXXXXXXXX3729

Remarks

jsk to Sairam industrial consultancy





**CITY UNION BANK**  
**BRANCH : POONTHANDALAM**  
**Sri Sairam Engineering College**  
**Campus Sai Leo Nagar**  
**POONTHANDALAM 600**  
**044**  
**Chennai Kancheepuram**  
**District**

**ACCOUNT NO : SB-13033729**  
**ACCOUNT NO(15 DIGIT) : 500101013033729**  
**IFSC : CIUB0000634**  
**ACCOUNT TYPE : CUB SAVINGS A/C OTHERS**  
**CUSTOMER DETAILS : SAIRAM INDUSTRIAL CONSULTANCY**  
**SRI SAIRAM INSTITUTE OF TECHNOLOGY**  
**SAI LEO NAGAR, POONTHANDALAM,**  
**BEHIND LEO COMPLEX T NAGAR**  
**CHENNAI**  
**600017**

**Statement Date : Mar 25, 2023, at 03:19 PM**  
**STATEMENT OF ACCOUNT from 01/03/2023 to 25/03/2023**

DATE	DESCRIPTION	CHEQUE NO	DEBIT	CREDIT	BALANCE
07/03/2023	BY NEFT TRF:HAKATETECH 000300722765:			5,850.00	1,72,705.00
09/03/2023	BY NEFT TRF:THERMAL ENERGY S AXIC230687075562:			20,000.00	1,92,705.00
11/03/2023	BY NEFT TRF:QUALITY ELECTRIC FDRH23070876938:			20,000.00	2,12,705.00
15/03/2023	BY NEFT TRF:RENUGA INDUSTRIE N074232372621133:			30,000.00	2,42,705.00
16/03/2023	BY ONL TRF: CA 510909010200481:00634			10,000.00	2,52,705.00
21/03/2023	BY CLEARING:000070-KIOSK-634-BY CTS:00121-CHQ NO 487721	487721		30,000.00	2,82,705.00
21/03/2023	BY ONL TRF: CA 510909010200481:00634			19,547.00	3,02,252.00
25/03/2023	BY NEFT TRF:JSK LAB INSTRUME P084230229796696:			30,000.00	3,32,252.00
TOTAL			0.00	1,65,397.00	3,32,252.00

\* Statement Downloaded By SAIRAM INDUSTRIAL CONSULTANCY on Mar 25, 2023, at 03:19 PM  
If any discrepancy in the statement, should be informed to branch immediately.  
END OF STATEMENT - from Internet Banking



# Sanjmar Industries (OPC) Private Limited

100B, Thiruvengadam Nagar, 8<sup>th</sup> Street, Mannivakkam, Chennai-600048.

[www.sanjmar.business.site](http://www.sanjmar.business.site)

E-mail: [sanjmar600048@gmail.com](mailto:sanjmar600048@gmail.com), Mobile: 8825461128, 8220903877

CIN: U28999TN2022OPC151345

GST: 33ABICS2622J1ZE

Date: 01/07/2022

## TO WHOMSOEVER IT MAY CONCERN

This is to certify that Mr. B. KARTHIKEYAN, Assistant Professor, Department of Mechanical Engineering, Sri Sai Ram Institute of Technology completed the Design of Con Mill and supported in Manufacturing the same, in this regard we made a payment of Rs. 1,00,000/- as a consultancy charges. We appreciate his work for the completion in time.

All the best for his future.



For SANJMAR INDUSTRIES (OPC) PRIVATE LIMITED

CHIEF EXECUTIVE OFFICER



# Sanjmar Industries (OPC) Private Limited

100B, Thiruvengadam Nagar, 8<sup>th</sup> Street, Mannivakkam, Chennai-600048.

[www.sanjmar.business.site](http://www.sanjmar.business.site)

E-mail: [sanjmar600048@gmail.com](mailto:sanjmar600048@gmail.com), Mobile: 8825461128, 8220903877

CIN: U28999TN2022OPC151345

GST: 33ABICS2622J1ZE

Date: 30/06/2022

## TO WHOMSOEVER IT MAY CONCERN

This is to certify that Dr. MARRESWARAN M, Associate Professor, Department of Mechanical Engineering, Sri Sai Ram Institute of Technology completed the Design of Steam Injected Kiln and supported manufacturing the same, in this regard we made a payment of Rs. 3,00,000/- in 6 instalments in the month of May and June 2022 as a consultancy charges. We appreciate his work for the completion in time.

All the best for his future.



For SANJMAR INDUSTRIES (OPC) PRIVATE LIMITED

CHIEF EXECUTIVE OFFICER



**CITY UNION BANK**  
**BRANCH : Poonthandalam**  
**Sri Sairam Engineering College**  
**Campus Sai Leo Nagar**  
**POONTHANDALAM 600**  
**044**  
**Chennai Kancheepuram**  
**District**

**ACCOUNT NO : SB-12080596**  
**ACCOUNT NO(15 DIGIT) : 500101012080596**  
**IFSC : CIUB0000634**  
**ACCOUNT TYPE : CUB SALARY SAVINGS**  
**CUSTOMER DETAILS : MAREESWARAN M**  
**SRI SAI RAM INSTITUTE OF TECHNOLOGY**  
**SAI LEO NAGAR**  
**WEST TAMBARAM**  
**CHENNAI**  
**600044**

**Statement Date : Sep 22, 2022, at 02:15 PM**  
**STATEMENT OF ACCOUNT from 01/04/2022 to 30/06/2022**

DATE	DESCRIPTION	CHEQUE NO	DEBIT	CREDIT	BALANCE
01/04/2022	BY ONL SAIRAM COWIN TOGETHER WE CAN::00001			39,832.00	55,842.38
03/04/2022	TO ATM WDL:1FNCHE61-2 40 LAKSHMI NAGAR KANCHIPURAM TNIN:		4,000.00		51,842.38
04/04/2022	TO ONL UPI/DR/209475328243/PHONEPEC/YESB/PHONEPECAR/P::00634		199.00		51,643.38
04/04/2022	TO ONL UPI/DR/209445357228/MRS B GA/IDIB/GACHI2907-/F::00634		2,000.00		49,643.38
04/04/2022	TO ONL UPI/DR/209445372796/SHAILASH/BARB/SHAILASHRE/F::00634		2,000.00		47,643.38
04/04/2022	TO ONL UPI/DR/209445470459/IOBA/1830010000/UPI::00634		3,500.00		44,143.38
04/04/2022	TO ONL UPI/DR/209455895907/PAYTM CR/PYTM/CCBILLPAY@/O::00634		40,000.00		4,143.38
04/04/2022	TO ONL UPI/DR/209449466569/SHAILASH/BARB/SHAILASHRE/U::00634		500.00		3,643.38
05/04/2022	TO ONL UPI/DR/209557533378/RENSHI K/SBIN/RENSHIKART/F::00634		600.00		3,043.38
05/04/2022	BY CREDIT:SAIRAMIT COE REMUNERATION:00634			150.00	3,193.38
05/04/2022	BY ONL UPI/CR/209592660377/NALLASIV/UTIB/NALLASIVAN/B::00032			333.00	3,526.38
05/04/2022	BY ONL UPI/CR/209517770288/NITHYA /SBIN/NITHYA93KI/D::00032			333.00	3,859.38
05/04/2022	BY ONL UPI/CR/209566046519/JOSE PRA/HDFC/MAIL2SPJOS/U::00032			333.00	4,192.38
06/04/2022	BY NEFT TRF:SRI SAIRAM INSTI 204052117873:			56,950.00	61,142.38
06/04/2022	TO ONL UPI/DR/209662505016/PHONEPE/YESB/BILLDESKHE/PA::00634		44,592.00		16,550.38
06/04/2022	BY ONL UPI/CR/209620520662/SHAKTHI /SIBL/SHAKTHI CH/U::00032			333.00	16,883.38
07/04/2022	BY ONL UPI/CR/209741689274/SAHAYA I/UTIB/SIRAJAN76@/U::00032			333.00	17,216.38
07/04/2022	TO ONL UPI/DR/209798970776/MR KARTH/CIUB/KARTHI NSB/U::00634		140.00		17,076.38
07/04/2022	TO ONL UPI/DR/209703782217/R MANIKA/SBIN/GAYUMANI12/U::00634		500.00		16,576.38
07/04/2022	TO ATM WDL:IOBD5354-MANNIVAKKAM KANCHEEPURAKANCHIPURAM TNIN:		2,000.00		14,576.38
09/04/2022	TO ONL UPI/DR/209931615496/DHEIVA P/SBIN/MP89395915/U::00634		300.00		14,276.38
21/04/2022	TO ATM WDL:CUB01624-MANNIVAKKAM II KANCHIPURAM TNIN:		1,500.00		12,776.38
22/04/2022	TO TRANSFER:BY DD:00634		210.00		12,566.38
23/04/2022	TO ONL UPI/DR/211307567325/SANJMAR /IDFB/MEGAMAREES/P::00634		1,000.00		11,566.38
01/05/2022	TO ATM WDL:C0119004- OLD PERUNGALATHUR II KANCHEEPURAM TNIN:		5,000.00		6,566.38
04/05/2022	TO ONL UPI/DR/212448211739/CHITHRAI/PYTM/PAYTM-4669/O::00634		166.00		6,400.38
05/05/2022	TO ONL UPI/DR/212536195521/MR MAREE/CBIN/0000000334/N::00634		5,000.00		1,400.38
05/05/2022	BY NEFT TRF:SRI SAIRAM INSTI 205053495708:			62,259.00	63,659.38
05/05/2022	TO ONL UPI/DR/212572074867/PAYTM CR/PYTM/PAYTM-NEFT/O::00634		200.00		63,459.38
05/05/2022	TO ONL UPI/DR/212520190468/IOBA/1830010000/UPI::00634		3,500.00		59,959.38
05/05/2022	TO ONL UPI/DR/212582548502/PAYTM CR/PYTM/CCBILLPAY@/O::00634		50,000.00		9,959.38
05/05/2022	BY ONL 0000IMPSIDF212522904456:SANJMAR IN/10089716040::00634			20,000.00	29,959.38
05/05/2022	TO ONL UPI/DR/212555144917/PHONEPE/YESB/BILLDESKHE/PA::00634		22,150.00		7,809.38
06/05/2022	TO ONL UPI/DR/212608411478/ASIYA MA/YESB/Q033808361/N::00634		200.00		7,609.38
06/05/2022	TO ONL UPI/DR/212633456916/RENSHI K/SBIN/RENSHIKART/F::00634		600.00		7,009.38
06/05/2022	BY ONL 0000IMPSIDF212619187873:SANJMAR IN/10089716040::00634			20,000.00	27,009.38
06/05/2022	TO ONL UPI/DR/212637057334/SHYAMALA/KVBL/SHYAMALABD/U::00634		20,000.00		7,009.38
07/05/2022	TO ONL UPI/DR/212770809017/MOHANRAJ/PYTM/PAYTM-6768/O::00634		100.00		6,909.38
08/05/2022	TO ONL UPI/DR/212818101368/SREE KRI/UTIB/9841452128/N::00634		415.00		6,494.38
10/05/2022	TO ONL UPI/DR/213074988781/MOHANRAJ/PYTM/PAYTM-6768/O::00634		160.00		6,334.38
11/05/2022	BY ONL 0000IMPSIDF213108574110:SANJMAR IN/FROM SANJMA::00634			50,000.00	56,334.38
11/05/2022	TO ONL UPI/DR/213121419559/SHYAMALA/KVBL/SHYAMALABD/U::00634		50,000.00		6,334.38
11/05/2022	BY ONL 0000IMPSIDF213108574544:SANJMAR IN/10089716040::00634			30,000.00	36,334.38





# CITY UNION BANK LTD

DATE	DESCRIPTION	CHEQUE NO	DEBIT	CREDIT	BALANCE
11/05/2022	TO ONL UPI/DR/213121449813/SHYAMALA/KVBL/SHYAMALABD/U::00634		30,000.00		6,334.38
11/05/2022	TO ONL UPI/DR/213144650132/VIDHYA F/UTIB/GPAY-11187/N::00634		70.00		6,264.38
13/05/2022	TO ONL UPI/DR/213371005801/VIDHYA F/UTIB/GPAY-11187/U::00634		230.00		6,034.38
14/05/2022	TO ONL UPI/DR/213479746303/MOHANRAJ/PYTM/PAYTM-6768/O::00634		130.00		5,904.38
15/05/2022	TO ONL UPI/DR/213597920337/MOHAMED /ICIC/Q983694589/U::00634		500.00		5,404.38
15/05/2022	TO ONL UPI/DR/213548407491/ADD MONE/PYTM/ADD-MONEY@/O::00634		390.50		5,013.88
16/05/2022	TO ONL UPI/DR/213605301651/CHITHRAI/PYTM/PAYTM-4669/O::00634		330.00		4,683.88
16/05/2022	TO ONL UPI/DR/213613730859/VIDHYA F/UTIB/GPAY-11187/N::00634		600.00		4,083.88
16/05/2022	TO ATM WDL:1283WS94- WSG PERUNGALATHUR NGOKANCHIPURAM TNIN:		1,500.00		2,583.88
16/05/2022	TO ONL UPI/DR/213639137012/VIDHYA F/UTIB/GPAY-11187/N::00634		350.00		2,233.88
16/05/2022	BY CREDIT:SAIRAMITCOE:00634			300.00	2,533.88
16/05/2022	BY CREDIT:SAIRAMITCOE:00634			150.00	2,683.88
16/05/2022	BY CREDIT:SAIRAMITCOE:00634			405.00	3,088.88
16/05/2022	BY CREDIT:SAIRAMITCOE:00634			150.00	3,238.88
18/05/2022	TO ONL UPI/DR/213844699376/SRM CYCL/UTIB/9551334460/N::00634		290.00		2,948.88
18/05/2022	TO ONL UPI/DR/213845055252/MAHADEV /UTIB/GPAY-11189/N::00634		210.00		2,738.88
18/05/2022	TO ONL UPI/DR/213845668482/CHITHRAI/PYTM/PAYTM-4669/O::00634		195.00		2,543.88
19/05/2022	TO ONL UPI/DR/213970988479/MS K A F/IDIB/FAIROZNISH/F::00634		700.00		1,843.88
22/05/2022	TO ONL UPI/DR/214212443988/CHITHRAI/PYTM/PAYTM-4669/O::00634		249.00		1,594.88
22/05/2022	TO ONL UPI/DR/214231529834/VSR SPOR/YESB/Q33249828@/N::00634		220.00		1,374.88
23/05/2022	BY CREDIT:REMUNERATION:00634			2,500.00	3,874.88
25/05/2022	TO ONL UPI/DR/214556812918/MAAURU C/UTIB/9842955771/N::00634		110.00		3,764.88
25/05/2022	TO ONL UPI/DR/214567322224/SHANMUGA/PYTM/PAYTM-6609/O::00634		430.00		3,334.88
27/05/2022	TO ONL UPI/DR/214780174130/MOHANRAJ/PYTM/PAYTM-6768/O::00634		50.00		3,284.88
28/05/2022	TO ONL UPI/DR/214863435804/VSR SPOR/YESB/Q33249828@/P::00634		220.00		3,064.88
28/05/2022	TO ONL UPI/DR/214861498283/VSR SPOR/YESB/Q33249828@/P::00634		220.00		2,844.88
29/05/2022	TO ATM WDL:SIACCN28- MANNIVAKKAM CHENNAI TNIN:		1,500.00		1,344.88
29/05/2022	TO ONL UPI/DR/21495955487/VSR SPOR/YESB/Q33249828@/P::00634		320.00		1,024.88
30/05/2022	BY ONL 0000IMPSIDF215013869483:SANJMAR IN/SANJMAR IND::00634			1,00,000.00	1,01,024.88
30/05/2022	TO ONL UPI/DR/215070877242/MADASAMY/CNRB/A MADASAAM/U::00634		1,00,000.00		1,024.88
04/06/2022	BY NEFT TRF:SRI SAIRAM INSTI 206043969835:			62,259.00	63,283.88
04/06/2022	TO ONL UPI/DR/215508156196/PHONEPEC/YESB/PHONEPECAR/P::00634		6,327.00		56,956.88
04/06/2022	TO ONL UPI/DR/215527006924/PHONEPE/YESB/BILLESKHE/PA::00634		16,000.00		40,956.88
04/06/2022	TO ONL UPI/DR/215581507588/IOBA/1830010000/UPI::00634		3,500.00		37,456.88
04/06/2022	TO ONL UPI/DR/215574761483/MR MAREE/CBIN/0000000334/N::00634		21,000.00		16,456.88
05/06/2022	TO ONL UPI/DR/215600401440/BOB ACCO/PYTM/PAYTM-6849/O::00634		500.00		15,956.88
05/06/2022	TO ONL UPI/DR/215619939241/KARIMULL/PYTM/PAY9840550/O::00634		420.00		15,536.88
05/06/2022	TO ONL UPI/DR/215685656786/PHONEPE/YESB/BILLESKHE/PA::00634		9,100.00		6,436.88
06/06/2022	TO ONL UPI/DR/215750209036/MR SARAV/CIUB/Q55383491@/P::00634		10.00		6,426.88
06/06/2022	TO ONL UPI/DR/215739569452/RAJANGAM/UTIB/GPAY-11169/P::00634		167.00		6,259.88
07/06/2022	TO ATM WDL:12837763- ALANDUR E B OFFIC KANCHIPURAM TNIN:		1,500.00		4,759.88
08/06/2022	TO ONL UPI/DR/215974037924/M G MOTO/YESB/Q387151604/P::00634		550.00		4,209.88
08/06/2022	TO ONL UPI/DR/215948574864/M G MOTO/YESB/Q387151604/P::00634		47.00		4,162.88
08/06/2022	TO ONL UPI/DR/215941690974/MOHANRAJ/PYTM/PAYTM-6768/O::00634		280.00		3,882.88
08/06/2022	TO ONL UPI/DR/215934876384/SHANMUGA/KVBL/Q771973281/P::00634		775.00		3,107.88
09/06/2022	TO ONL UPI/DR/216006087105/FATHIMA /PYTM/PAYTM-2811/O::00634		340.00		2,767.88
10/06/2022	TO ONL UPI/DR/216190844575/MR CHAND/CIUB/CHANDRANAR/U::00634		744.00		2,023.88
10/06/2022	TO ONL UPI/DR/216197705732/MS K A F/IDIB/FAIROZNISH/F::00634		1,800.00		223.88
11/06/2022	TO ONL UPI/DR/216262904579/CHITHRAI/PYTM/PAYTM-4669/O::00634		209.00		14.88
20/06/2022	BY ATM CASH DEPOSIT:CUB02017-POONDHANDALAM KANCHEEPURAM TNIN:			19,000.00	19,014.88
22/06/2022	TO ONL UPI/DR/217348685234/PHONEPE/YESB/BILLESKHE/PA::00634		10,000.00		9,014.88
23/06/2022	TO ONL UPI/DR/217416600367/PHONEPEC/YESB/PHONEPECAR/P::00634		2,000.00		7,014.88
23/06/2022	BY ATM CASH DEPOSIT:CUB02017-POONDHANDALAM KANCHEEPURAM TNIN:			25,000.00	32,014.88
23/06/2022	TO ONL UPI/DR/217446967612/PHONEPE/YESB/BILLESKHE/PA::00634		25,000.00		7,014.88
24/06/2022	BY ATM CASH DEPOSIT:CUB02017-POONDHANDALAM KANCHEEPURAM TNIN:			25,000.00	32,014.88
24/06/2022	TO ONL UPI/DR/217576672045/JAYALAKS/PUNB/8667074544/P::00634		20,000.00		12,014.88
25/06/2022	BY ONL 0000IMPSAXB217610947241:SHAHULHAME/91602004363::00634			50,000.00	62,014.88
25/06/2022	BY ONL UPI/CR/217612661753/SHAHUL H/SBIN/9842133307/P::00032			1.00	62,015.88
25/06/2022	BY ONL UPI/CR/217649565348/SHAHUL H/SBIN/9842133307/P::00032			50,000.00	1,12,015.88
25/06/2022	TO ONL RATNAKAR:PAYMENT::00634		94,040.70		17,975.18
27/06/2022	TO ONL UPI/DR/217819379142/MR S MUN/CIUB/Q63714959@/P::00634		571.00		17,404.18
27/06/2022	TO ONL UPI/DR/217824923284/KRISHNA /YESB/BHARATPE09/P::00634		900.00		16,504.18
27/06/2022	TO POS:44084627-SIVASAKTHI SUPER MARK CHENNAI TNIN:		179.00		16,325.18
28/06/2022	TO ONL UPI/DR/217945780486/MOHANRAJ/PYTM/PAYTM-6768/O::00634		360.00		15,965.18
28/06/2022	BY ONL 0000IMPSHDB217920818324:HDFC BANK/PAYZAPP - MA::00634			14,600.00	30,565.18
29/06/2022	TO POS:BIB00151-GEM HOSPITAL AND RESEARCHENNAI TNIN:		15,500.00		15,065.18
29/06/2022	TO POS:BIB00154-GEM HOSPITAL AND RESEARCHENNAI TNIN:		5,261.00		9,804.18
29/06/2022	TO POS:60377918-GEM PHARMACY CHENNAI CHENNAI TNIN:		508.00		9,296.18
29/06/2022	TO POS:44086585-SIVASAKTHI SUPER MARK CHENNAI TNIN:		506.00		8,790.18
29/06/2022	TO ONL UPI/DR/218071992381/CHITHRAI/PYTM/PAYTM-4669/O::00634		313.00		8,477.18



DATE	DESCRIPTION	CHEQUE NO	DEBIT	CREDIT	BALANCE
30/06/2022	BY ONL 0000IMPSIDF218115247321:SANJMAR IN/10089716040::00634			80,000.00	88,477.18
30/06/2022	TO ONL UPI/DR/218185370747/PHONEPE/YESB/BILLDESKHE/PA::00634		70,000.00		18,477.18
30/06/2022	BY NEFT TRF:RBL BANK 000257918507:			2,16,000.00	2,34,477.18
30/06/2022	TO ONL UPI/DR/218164415488/SANJMAR /IDFB/1008971604/N::00634		10,000.00		2,24,477.18
30/06/2022	TO ONL UPI/DR/218153315584/LAZY PAY/HDFC/LAZYPAY PA/U::00634		9,601.15		2,14,876.03
30/06/2022	BY CREDIT INTEREST:99999			90.00	2,14,966.03
TOTAL			7,27,355.35	9,26,311.00	2,14,966.03

\* Statement Downloaded By MAREESWARAN M on Sep 22, 2022, at 02:15 PM

If any discrepancy in the statement, should be informed to branch immediately.

END OF STATEMENT - from Internet Banking

A/C



ADYAR BRANCH, FIRST FLOOR, DOOR NO.9, 3RD AVENUE,, CHENNAI - 600020  
IFSC Code : IDFB0080105

Valid for three months from the date of issue

01072022  
D D M M Y Y Y Y

Pay **B. KARTHIKEYAN**

Or Bearer  
या धारक को

Rupees **One Lakh only**  
रुपये

अदा करें ₹ **1,00,000/-**

SESHAASAI \ CTS-2010  
3320754 / ( 50 )  
21/04/2022

A/c No. खाता सं.	<b>10089716040</b>
---------------------	--------------------



*M. [Signature]*

**SANJMAR INDUSTRIES (OPC) PRIVATE LIMITED**

Payable at par at all branches of IDFC FIRST Bank Ltd in India

Please sign above / कृपया यहां हस्ताक्षर करें

⑈000001⑈ 6007510061 000815⑈ 29

---

**Request for consultancy**

2 messages

---

**Revo Technologies and Enterprises** <revotech.pdkt@gmail.com>  
To: mareeswaran.mech@sairamit.edu.in

Thu, Oct 27, 2022 at 3:39 PM

Dear Sir,

In continuation with Telephonic discussion, PFA attached drawing for your reference, we need consultancy to fabricate the same, as discussed we will pay Rs.30000/- as consultancy charges to complete the project, the same need to be installed at IIT Madras at the earliest. Kindly confirm the same by reply mail.

Thanking you.

Regards,

M. Anandhi

CEO

REVO TECHNOLOGIES AND ENTERPRISES,

100B, 8th Street, Shanmuga Nagar,

Mannivakkam,

Chennai-600048

Tamil Nadu, india.

[www.revotechnologies.net](http://www.revotechnologies.net)

8220903877

**sector1 Fab DIM (1) (1).PDF**

30K

---

**Dr. MAREESWARAN M** <mareeswaran.mech@sairamit.edu.in>  
To: Revo Technologies and Enterprises <revotech.pdkt@gmail.com>

Fri, Oct 28, 2022 at 9:45 AM

Dear madam,

Thanks for your mail. I accept and complete this work at the earliest.

Thanking you once again.

Regards,

Dr. M.Mareeswaran

Asst.Prof Grade-II

Department of Mechanical Engineering

Sri Sai ram Institute of Technology

West tambaram

Chennai-600044.

9940812937, 8825461128

[Quoted text hidden]



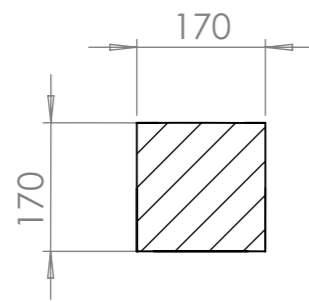
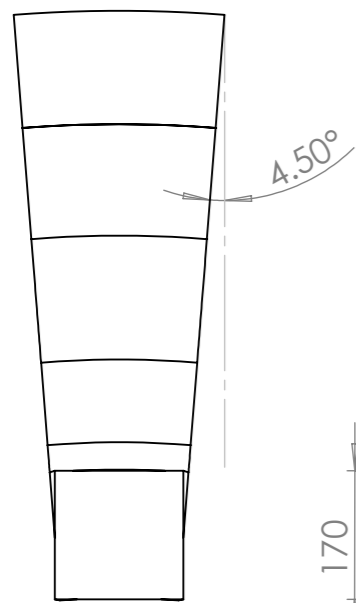
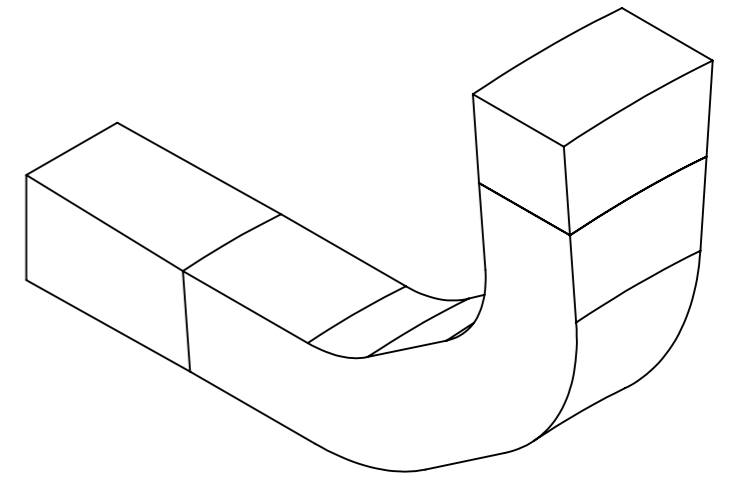
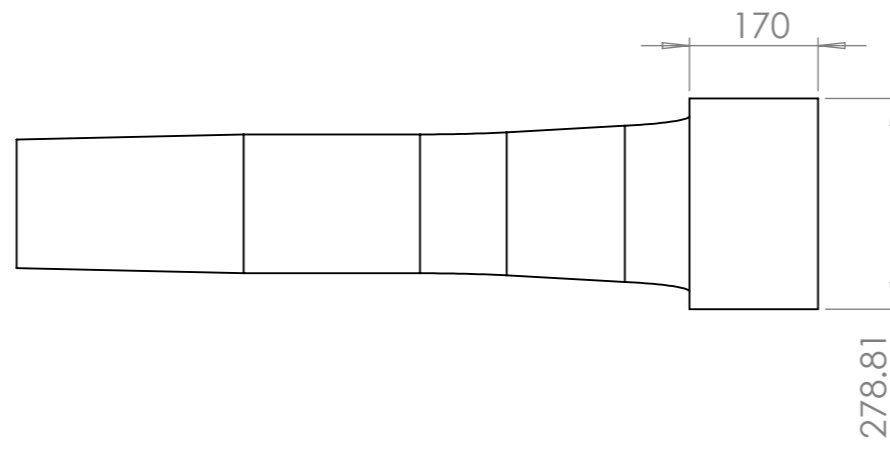

SECTION C-C

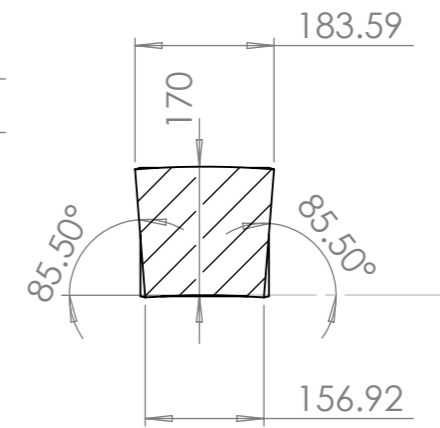
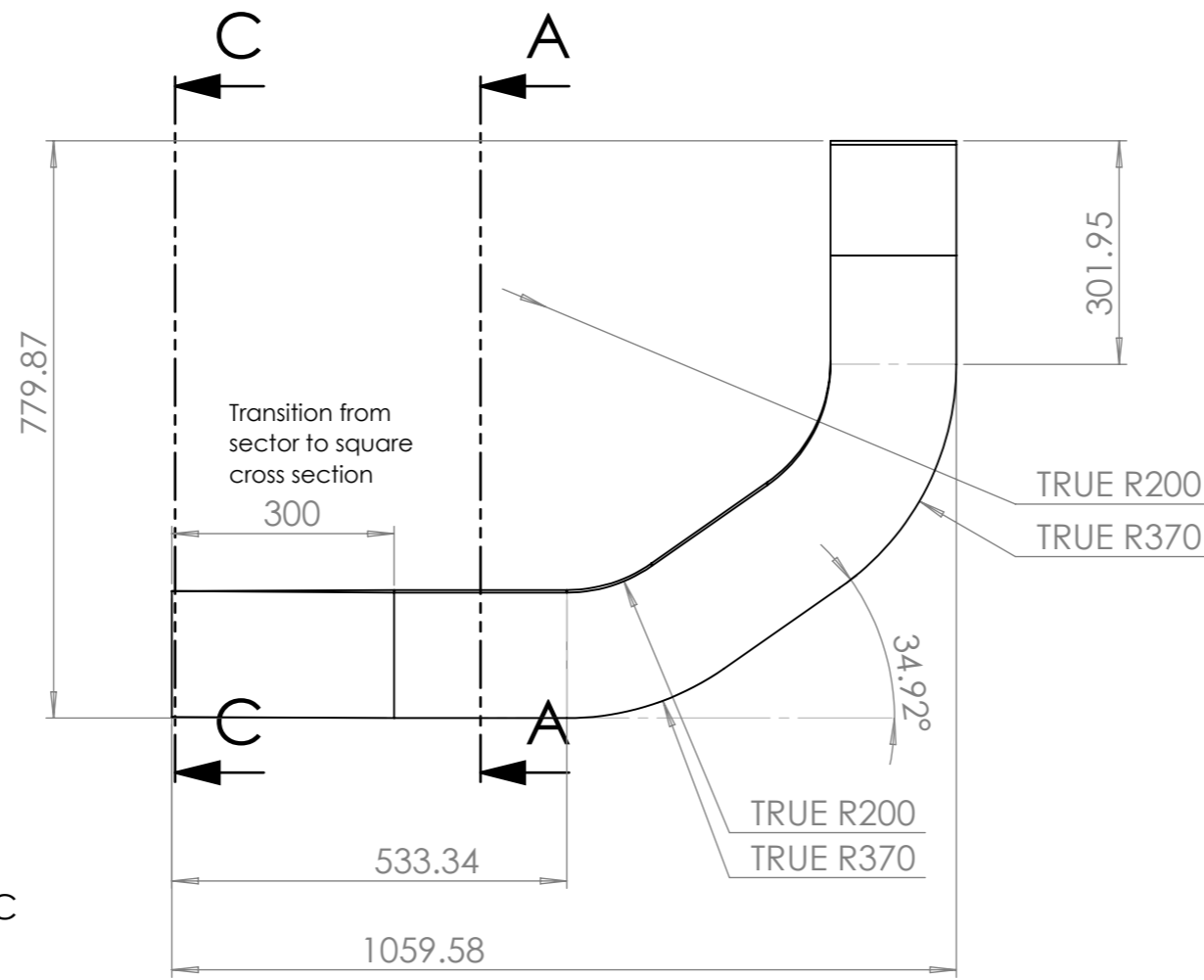

SECTION A-A

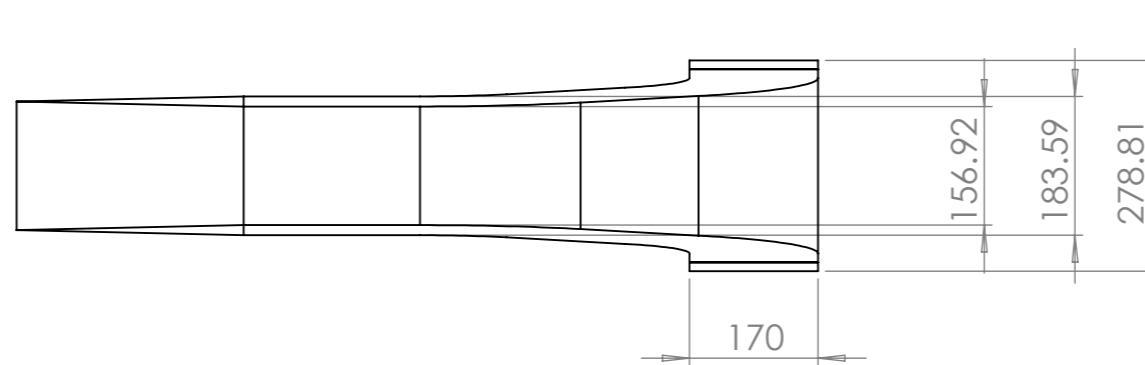



$$\begin{array}{r} 583.84 \\ 300 \\ \hline 283.84 \\ 2 \\ \hline 141.92 \end{array}$$

$$\begin{array}{r} 117 \quad 412 \\ 230 \\ 2 \\ \hline \end{array}$$

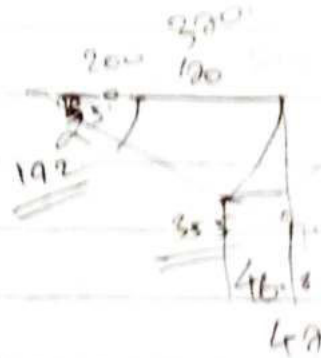
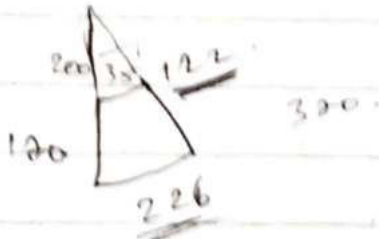
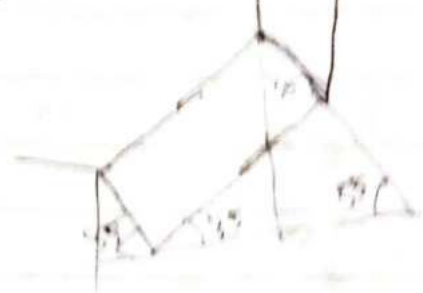

$$\text{Arc length} = \theta \times \frac{\pi}{180} \times r$$

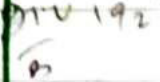
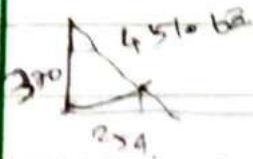

$$\frac{370}{192} = \frac{60}{\theta}$$

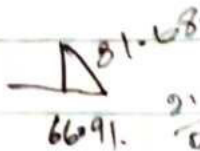
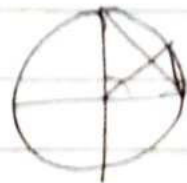

$$\frac{370}{192} = \frac{60}{\theta}$$

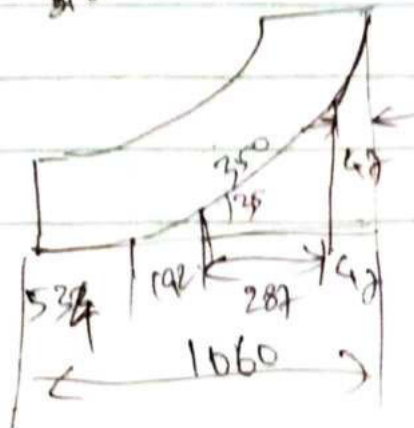
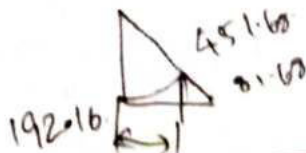

255 10x7H 5  
 = 70 + 5  
 = 75

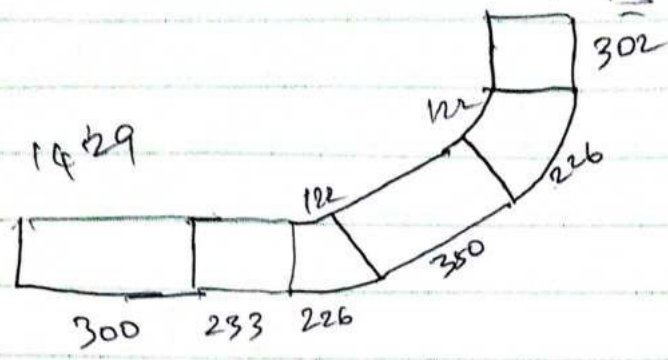

1637 x 100

416.5

1429 x 10

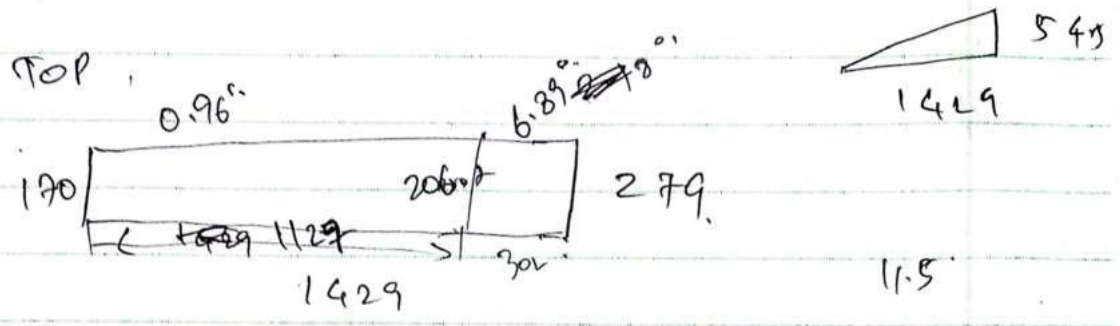

Bottom

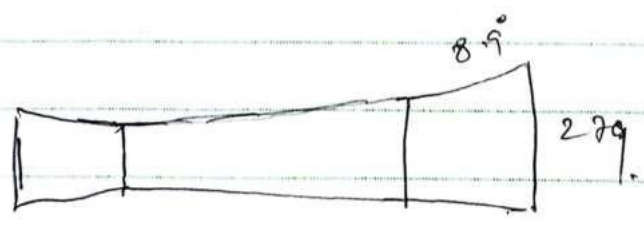
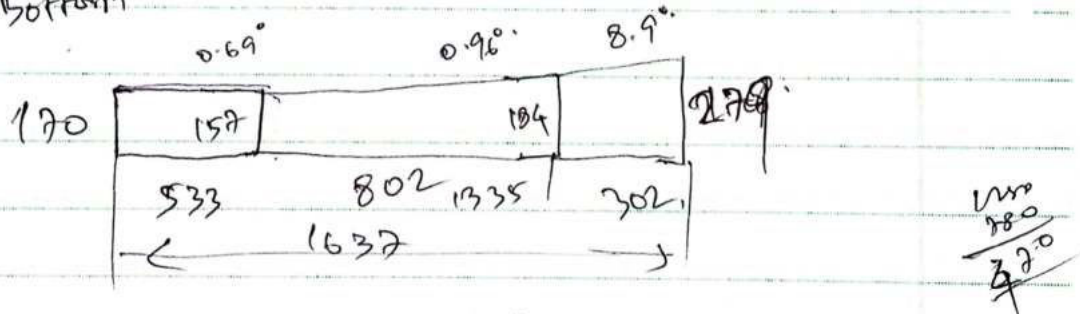

1128  
 1335

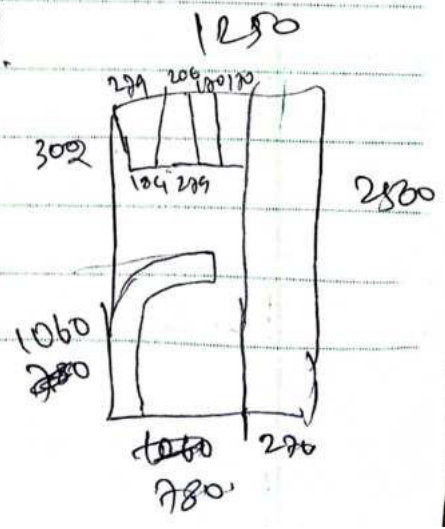

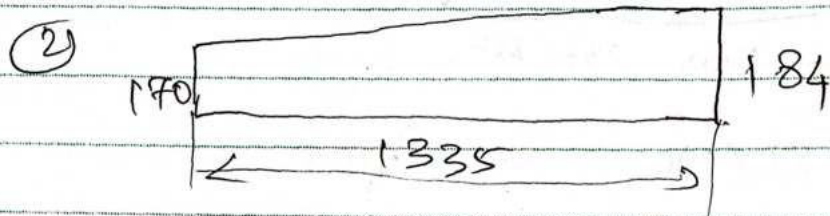
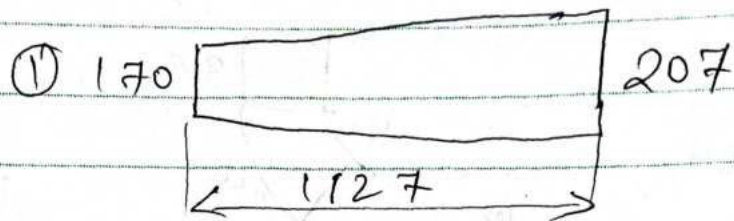

③ 170 x 302 — ② nos

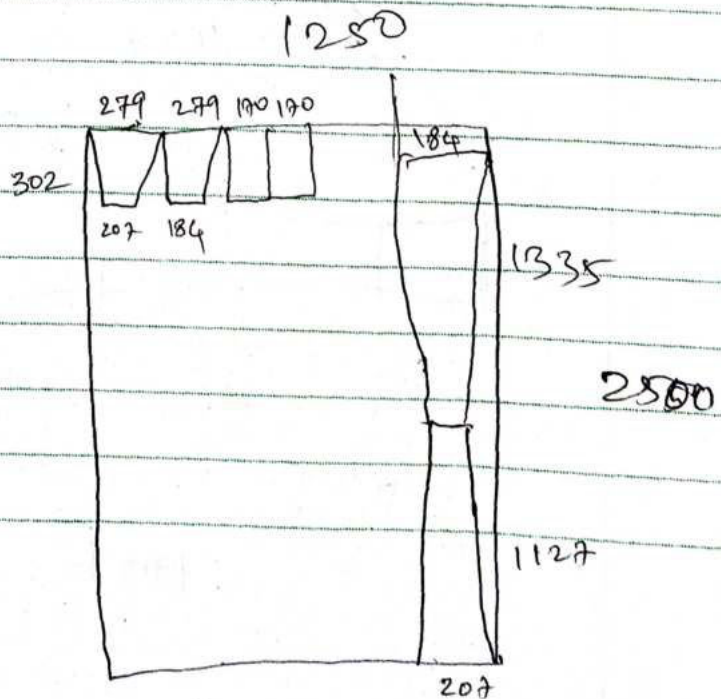
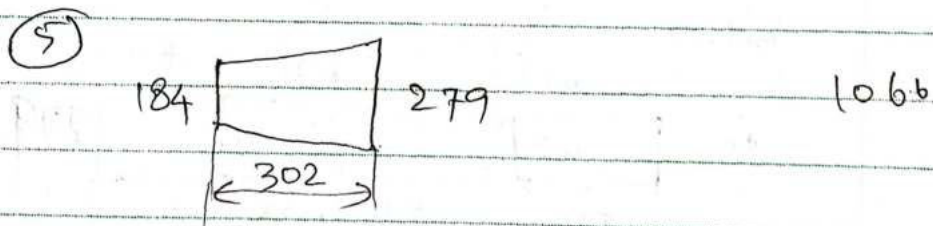
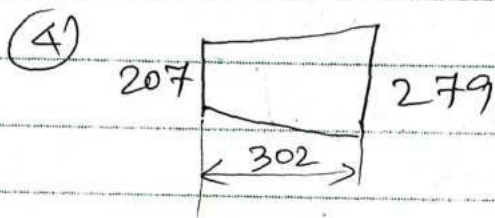

170 →



# REVOTECHNOLOGIES AND ENTERPRISES

An ISO 9001:2015 Certified Company

100B, 8th Street Shanmuganagar, Mannivakkam, Chennai-600048, Tamil Nadu, India

[www.revotechnologies.net](http://www.revotechnologies.net)

E-Mail: [info@revotechnologies.net](mailto:info@revotechnologies.net), [revotech.pdk@gmail.com](mailto:revotech.pdk@gmail.com)

Mobile: 9940812937, 9445470317

TIN: 33146367358



GST : 33AOXPM4580J1ZA

Date: 14/12/2022

## TO WHOMSOEVER IT MAY CONCERN

This is to certify that **Dr. MAREESWARAN M**, Associate Professor, Department of Mechanical Engineering, Sri Sai Ram Institute of Technology, Chennai completed the following project at IIT Madras;

### **Design and Installation of Customized Nozzle based Duct for Wind Tunnel**

We made payment of **Rs.30,000/-** (Rupees Thirty Thousand only) by means of Cheque in the name of **SAIRAM INDUSTRIAL CONSULTANCY**, dated 14/12/2022 vide cheque number 981932.

Thanking you.



Yours truly,  
For REVO TECHNOLOGIES AND ENTERPRISES

M. ANANDHI  
CEO



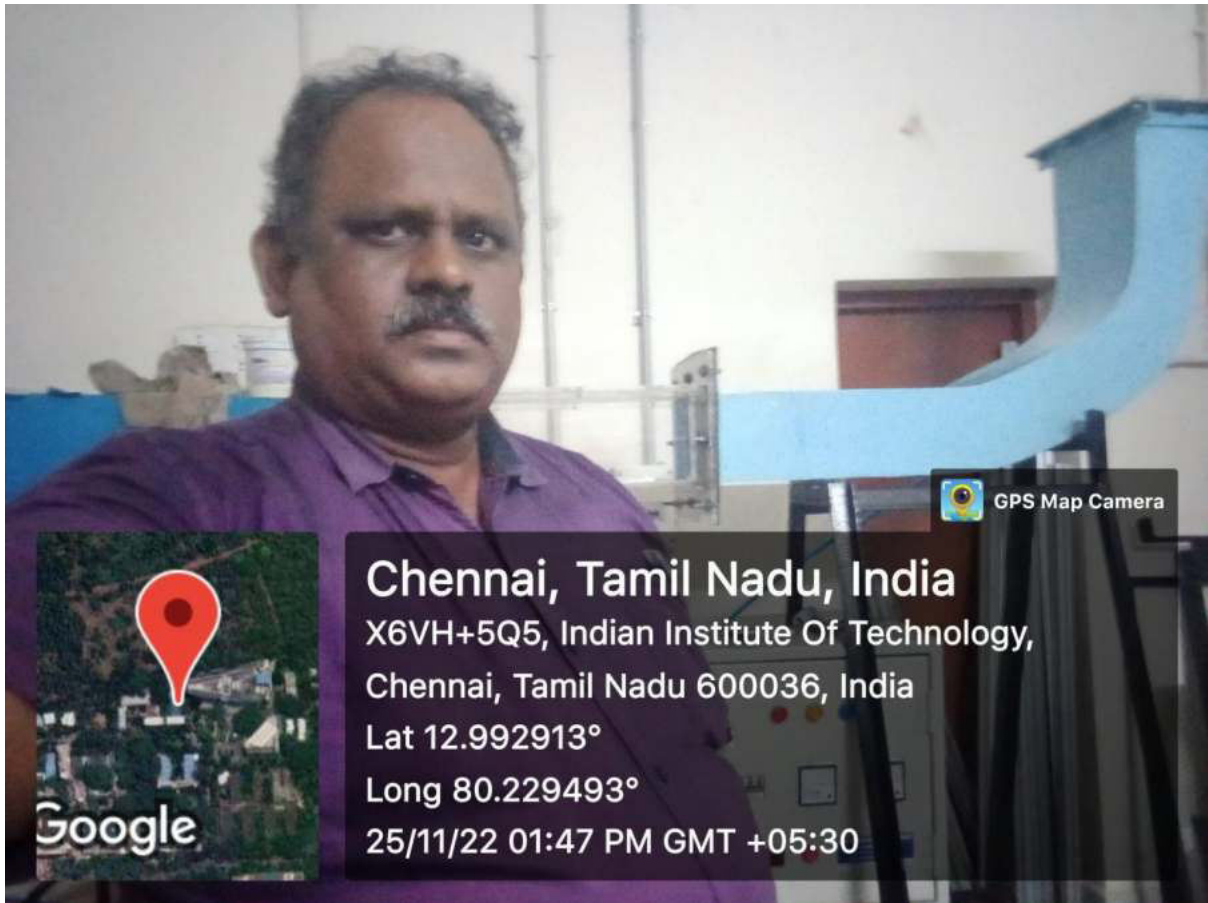

**Chennai, Tamil Nadu, India**

X6VH+5Q5, Indian Institute Of Technology,

Chennai, Tamil Nadu 600036, India

Lat 12.992913°

Long 80.229493°

25/11/22 01:47 PM GMT +05:30



**Chennai, Tamil Nadu, India**

X6VH+5Q5, Indian Institute Of Technology,

Chennai, Tamil Nadu 600036, India

Lat 12.992945°

Long 80.229491°

25/11/22 02:20 PM GMT +05:30





इंडियन बैंक

Indian Bank

Branch : MUDICHUR  
NO 4, Mudichur Road  
MUDICHUR, Chennai ( Tamil Nadu)  
IFS Code :IDIB000M274

VALID FOR THREE MONTHS ONLY

1	4	1	2	2	0	2	2
D	D	M	M	Y	Y	Y	Y

PAY SAIRAM INDUSTRIAL CONSULTANCY

या धारक को OR BEARER

RUPEES रुपये THIRTY THOUSAND ONLY

अदा करें ₹ 30000/-

खा. सं.  
A/c No. CA 6487646296

FOR REVO TECHNOLOGIES AND ENTERPRISES

CBS Code: 02420

PROPRIETOR

PAYABLE AT PAR AT ALL OUR BRANCHES

Please sign above

992000084

⑈981932⑈ 600019247⑈ 646296⑈ 29